

INSTALLATION / OPERATING MANUAL

FULL HD MEGA-PIXEL RUGGED IR PTZ CAMERA



Before attempting to connect or operate this product,
please read these instructions carefully and save this manual for future use.

TABLE OF CONTENTS

1. INFORMATION FOR USER	3p.
1.1 WARNING	3p.
1.2 EXPLANATION OF GRAPHICAL SYMBOLS	3p.
1.3 FCC COMPLIANCE STATEMENT	3p.
1.4 CE COMPLIANCE STATEMENT	3p.
2. PRECAUTIONS	4p.
3. FEATURES	5p.
4. SETTING & INSTALLATION	6p.
4.1 Unpacking	6p.
4.2 DIP Switch Setting	7p.
4.3 Cable Connection	9p.
4.4 Installation	10p.
4.5 Basic Configuration of the System	13p.
5. MAIN SETUP MENU	14p.
5.1 Initialize	14p.
5.2 Motion Setting	14p.
5.3 DOME Setting	35p.
5.4 Clear Setting.....	42p.
5.5 Factory set.....	42p.
5.6 PTZ Reset.....	42p.
6. SPECIFICATIONS	43p.
7. DIMENSIONS	45p.
7.1 Standard Model	45p.
7.2 Optional Bracket (Vihechle bracket).....	46p.
8. TROUBLE SHOOTING	47p.

1. INFORMATION FOR USER

1.1 WARNING

TO REDUCE THE RISK OF FIRE OR ELECTRIC SHOCK, DO NOT EXPOSE THIS PRODUCT TO RAIN OR MOISTURE. DO NOT INSERT ANY METALLIC OBJECTS THROUGH THE VENTILATION GRILLS OR OTHER OPENINGS ON THE EQUIPMENT.



CAUTION
RISK OF ELECTRIC SHOCK
DO NOT OPEN



CAUTION TO REDUCE THE RISK OF ELECTRIC SHOCK,
DO NOT REMOVE COVER (OR BACK).
NO USER SERVICEABLE PARTS INSIDE.
REFER SERVICING TO QUALIFIED
SERVICE PERSONNEL.

1.2 EXPLANATION OF GRAPHICAL SYMBOLS



The lightning flash with an arrowhead symbol, within an equilateral triangle is intended to alert the user to the presence of uninsulated "dangerous voltage" within the product's enclosure that may be of sufficient magnitude to constitute a risk of electric shock to persons.



The exclamation point within an equilateral triangle is intended to alert the user to the presence of important operating and maintenance (servicing) instructions in the literature accompanying the appliance.

1.3 FCC COMPLIANCE STATEMENT

FCC INFORMATION - This equipment has been tested and found to comply with limits for a Class A digital device, pursuant to part 15 of the FCC Rules. These limits are designed to provide reasonable protection against harmful interference when the equipment is operated in a commercial environment. This equipment generates, uses, and can radiate radio frequency energy and, if not installed and used in accordance with the instruction manual, may cause harmful interference to radio communications. Operation of this equipment in a residential area is likely to cause harmful interference in which case the user will be required to correct the interference at his own expense.

1.4 CE COMPLIANCE STATEMENT

WARNING - This is a CLASS A product. In a domestic environment this product may cause radio interference in which case the user may be required to take adequate measures.

CAUTION - Changes or modifications not expressly approved by the manufacturer could void the user's authority to operate the equipment.

* * This installation should be made by a qualified service person and should conform to all local

* **This manual is subject to change without notice for product improvement.**

2. PRECAUTIONS

- **Do not install the camera in extreme temperature conditions.**

Do not use the camera under conditions where temperatures are within -20°C to 50°C (in continuous operation). Under high temperatures, ensure proper ventilation.

- **Do not install or use the camera in an environment where the humidity is high.**

It can cause the image quality to be poor.

- **Do not install the camera under unstable lighting conditions.**

Severe lighting change or flicker can cause the camera to work improperly.

- **Never use the camera close to a gas or oil leak.**

It can cause malfunctions to occur.

- **Do not disassemble the camera.**

There are no user-serviceable parts inside it.

- **Do not drop the camera or subject them to physical shocks.**

It can cause malfunctions to occur.

- **Do not allow direct sunlight into the camera.**

It can damage CCD.

- **Do not expose the camera to rain or spill beverages on it.**

If it gets wet, wipe it dry immediately. Liquids can contain minerals that corrode the electronic components.

- **To prevent electric shock and risk of fire hazards.**

- **Do not use power sources other than that specified.**

- **Note**

If the camera is exposed to spotlight or object reflecting the strong light, smear or blooming may occur.

Please check the power whether it satisfies the normal specification before connecting the camera.

3. FEATURES

Specially useful for Police car and other special application

This stable and reliable design makes ideal for car application such as traffic monitoring, car surveillance.

Auto-focus x20 Optical Zoom

The built-in x20 optical zoom lens with auto-focus is combined with a x32 digital zoom, providing a maximum of x640 zoom.

3 60° Endless Pan Rotation (15° to 270° Tilt Angle)

Wide Range Auto functions

Preset : Up to 255 programmable Presets.

Tour : Up to 8 programmable Tours consisting of presets with individual dwell time.

Group : Up to 6 programmable Groups.

Scan : Repeatedly pan & tilt operating between two positions. (Max.8)

Pattern : Up to 4 programmable Patterns memorized the PTZ movement.

Alarm : Move the camera to programmed Preset position with Alarm trigger.(Max.2)

Area : Up to 16 programmable Areas display set.

Built-in Fan & Heater

T rue Day & Night (ICR Filter Change)

The IR cut filter is on when the camera is operating as a color camera for precise color reproduction. With ICR, the filter is removed which allows for much greater light sensitivity in monochrome mode.

OSD (On Screen Display)

The camera IDs, camera preset numbers, preset names, area names and camera operation status are displayed on the monitor, allowing set up of various camera functions through the OSD menu screen.

Mechanical Auto Flip

WDR (Wide dynamic range)

The Camera delivers clear, high quality pictures even in backlight, by increasing exposure in dark areas while decreasing it in bright areas a corrected image with clear details results

Variable speed Pan/Tilt control

In manual mode, sophisticated operating is possible at zoom in state by speed correcting function.

Light Function

It's builtin 12 Pcs IR LED, So it provides visible distance up to 120m in dark.

4. SETTING & INSTALLATION

4.1 Unpacking

Base plate bracket

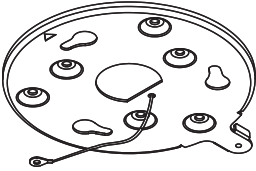

4PIN Plugable Terminal Block

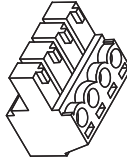

Manual

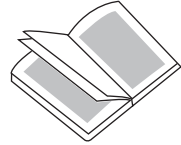

Alarm Cable

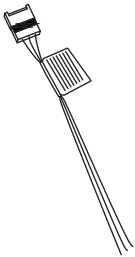

Main Cable

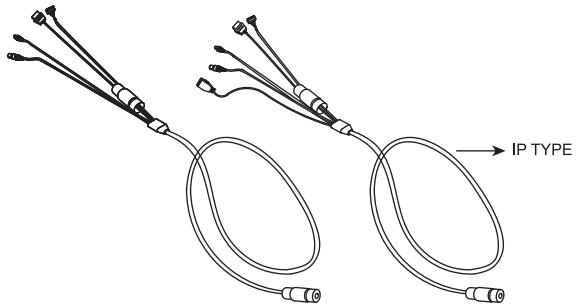

Screws

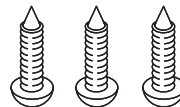

1. BH 3 x 6 (Screw for base plate with camera)
2. TH 3 x 6 (Screw for safety cable)

8 x 38 (Screw to fix the base plate bracket)

4.2 DIP Switch Setting

Before start up the camera, set the protocol, camera address and details with dip-switches referring to the follows.

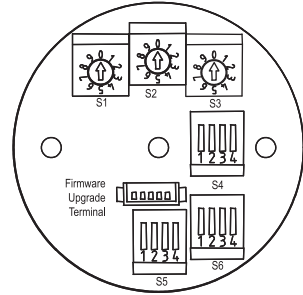
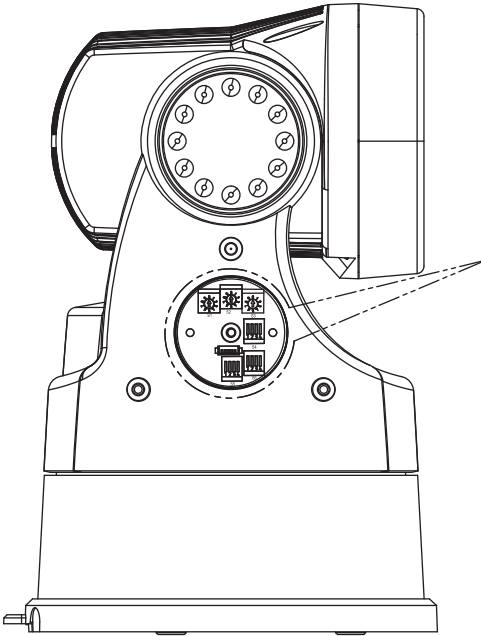

Open the left side of cover and set the camera

Camera ID (ADDRESS)

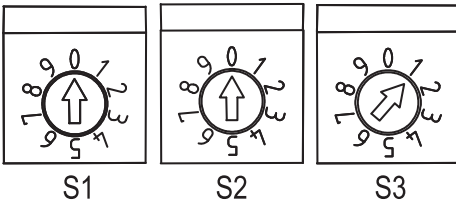

S1 : 100 digit of ID
 S2 : 10 digit of ID
 S3 : 1 digit of ID

Ex) S1=0, S2=0, S3=1

Address=001

Each camera must have a unique address(ID). Identical IDs on the same line may damage the control circuit caused by an electronic short.

DIP switch



Firmware
Upgrade
Terminal



S4

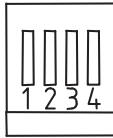

S6

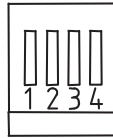

S5

S4		
PROTOCOL	1	2
PELCO D	OFF	OFF
PELCO P	OFF	ON
WTX	ON	OFF
EZ P	ON	ON

S4	
V TYPE	3
NTSC	OFF
PAL	ON

S4	
IP SEL	4
OFF	OFF
ON	ON

S6			
BAUDRATE	1	2	3
2400	OFF	OFF	OFF
4800	OFF	OFF	ON
9600	OFF	ON	OFF
19200	OFF	ON	ON
38400	ON	OFF	OFF
57600	ON	OFF	ON
115200	ON	ON	OFF
NC	ON	ON	ON

S6	
RS MODE	4
RS422	OFF
RS485	ON

S5	
INSTALL TYPE	1
TOP	OFF
BOTTOM	ON

S5	
RS LOOP	2
OFF	OFF
ON	ON

S6	
WTX-2000S	4
ON	ON
OFF	OFF

4.3 Cable Connection

4.3.1 Basic Diagram of Cable Connection

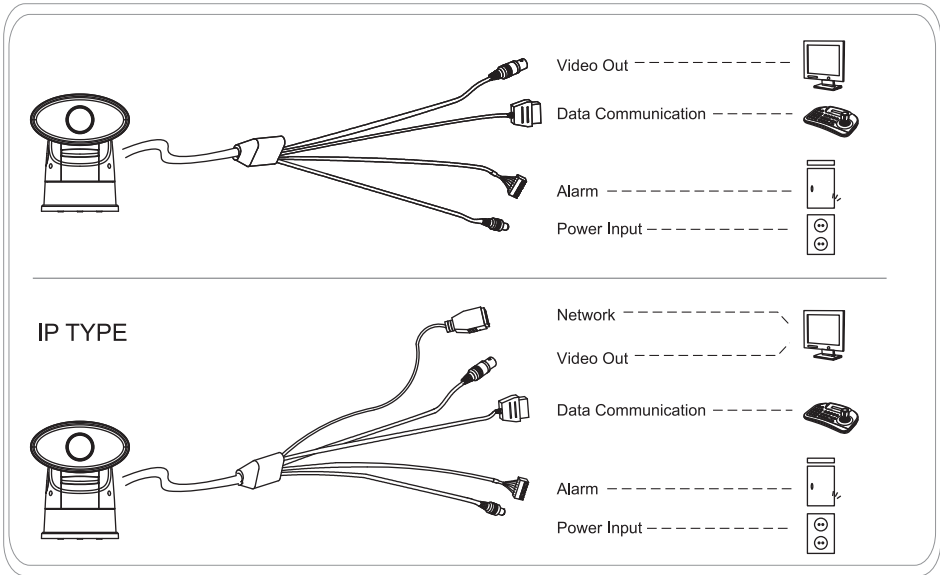

4.3.2 Video Output Connection

Connect the video out (BNC) connector to the monitor or video input of DVR.

4.3.3 RS-485 / RS-422 Communication Connection

Rugged IR PTZ camera can be remotely controlled by an external device or control system, such as a control keyboard or DVR, using RS-485 half-duplex, RS-422 duplex or simplex serial data communication signals. After inserting 4pin plugable terminal block of accessory package to green port of main cable, then connect marked RX+, RX- to TX+, TX- of the RS-485 control system. If control system is RS-422, connect TX+, TX- of controller to RX+, RX- of the camera. And also connect the TX+, TX- of camera to RX+, RX- of the control device respectively. Total length of the cable for communication should not exceed 1.2Km.

4.3.4 Alarm Connection

Rugged IR PTZ camera can operate specific motion receiving external Alarm Device(Sensor)'s signal (Max 2 Alarm.) Connect the alarm cable to external Alarm Device referring to below.

Ground : Brown color lines

Alarm 1 : Black color lines + Brown color lines, Alarm 2 : Red color lines + Brown color lines

4.3.5 Power Connection

- After connecting above 3 connections(Video/Data Communication/Alarm), connect the power cable finally.
- Connect the power of DC12V~24V
- Use certified Class 2 power supply transformer only.

4. 4 Installation

- The following steps of installation and connection work should be done by qualified service personnel or system installers and should confirm to all local codes.
- Be sure to switch the camera off before installation is completed.
- Do not install the camera near the air outlet of an air conditioner.
- Before installation, set camera system with Dip-switches on the 7~8 pages.

4. 4. 1 Typical Installation

1

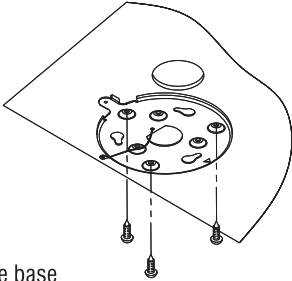

Fix the base plate after make holes on the ceiling.

2

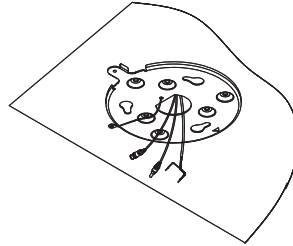

Pull out the cable where the camera will be installed.

3

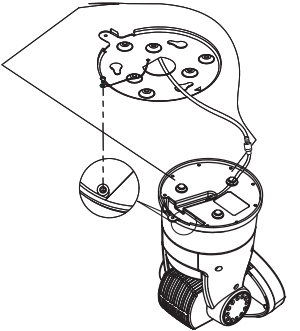

Connect the safety wire to the camera base and base plate using enclosed screws (TH 3x6).

4

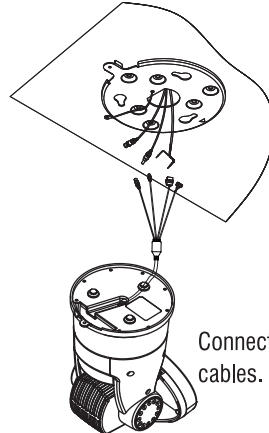

Connect the main cables.

5

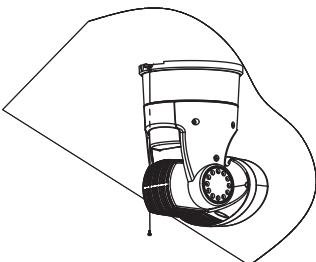

Fix the screw (BH 3x6) after fix the camera on the ceiling.

4. 4. 2 Installation for vehicle application

To install Rugged IR PTZ Camera to Vehicle, Bracket must be needed.
This bracket is provided optionally. (VB1)

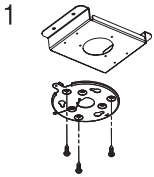
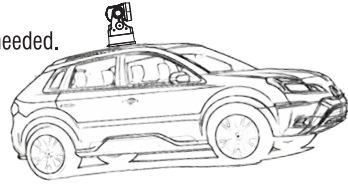

1 Attached the camera base plate to the bracket base plate by using M4x8 SUS screws.

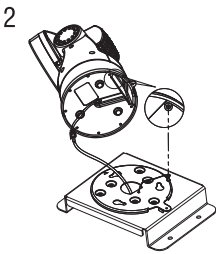

2 Connect the safety wire of camera base plate to the bottom of camera by using TH3x6 screws. (Screws are enclosed in the accessory pack)

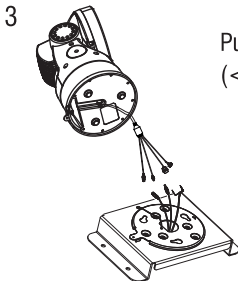

3 Pull out the cable from the hole of bracket base plate and connect with camera. (<--- See picture No.3)

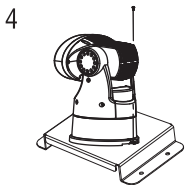

4 Fix the screw (PH3x6) with the camera body and camera base plate. (Screws are enclosed in the accessory pack)

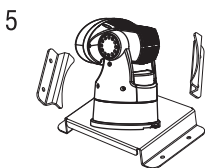

5 Attach the guide plate to the bracket base by using M4x8 screws.

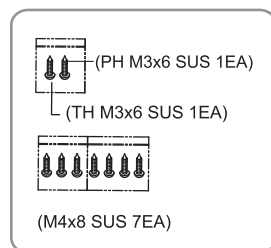

4. 4. 3 Installation for vehicle application

To install Rugged IR PTZ Camera to Vehicle, Bracket must be needed.
This bracket is provided optionally. (VB2)

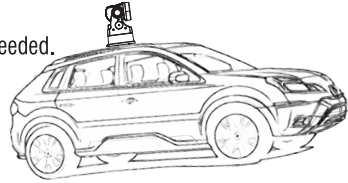

Attached the camera base plate to the bracket base plate by using M4x8 SUS screws.

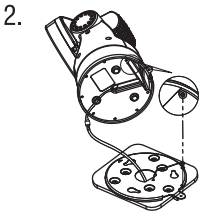

Connect the safety wire of camera base plate to the bottom of camera by using TH3X6 screws.(Screws are enclosed in the accessory pack)

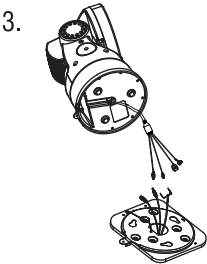

Pull out the cable from the hole of bracket base plate and connect with camera.
(<--- See picture no.3)

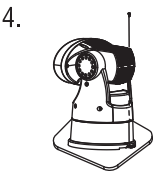

Fix the screw (PH 3x6) with the camera body and camera base plate.
(Screws are enclosed in the accessory pack)



Attach the guide plate to the bracket base by using screws.
(M4x8 TH / M4 SPRING W/S)

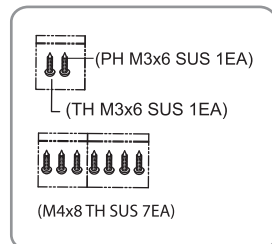

4.5 Basic Configuration of the System

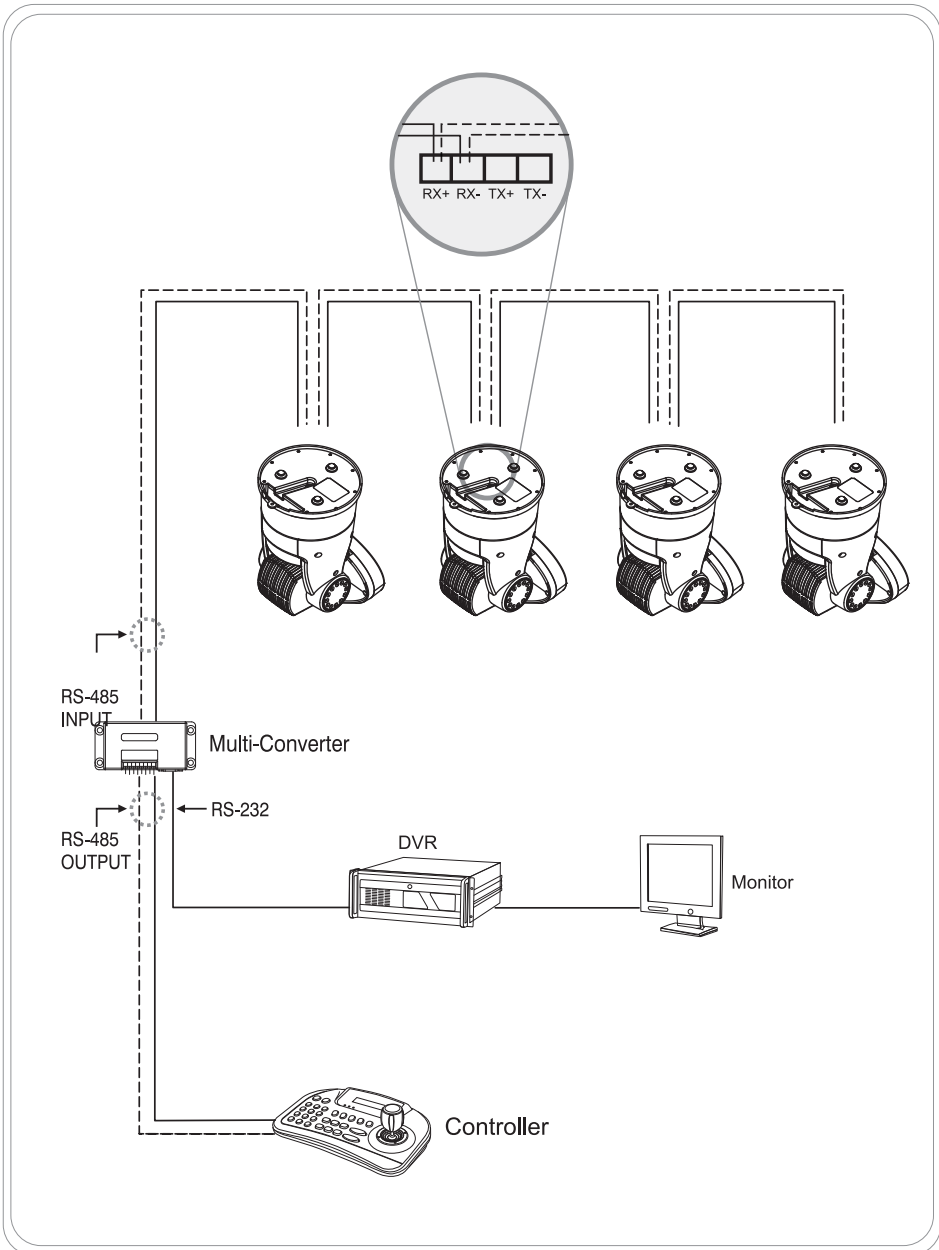

5. MAIN SETUP MENU

5.1 Initialize

When the device is powered on, you can check the address, version, protocol and video setting values.

```

INITIALIZE
PTZ ID      : 001
VERSION    : X. XX
D-OUTPUT   : 1080p30/NTSC

PROTOCOL   : PELCO-D
BAUDRATE   : 2400.N.1
CAMERA     : XX XXX. OK
            VER: XX, XX
▷ PAN INIT : ..... OK
▷ TILT INIT: ..... OK

▷ NORMAL SETTING WAIT ...
    
```

5.2 Motion Setting

5.2.1 Preset

```

MAIN MENU
-----
MOTION ▶
DOME      ▷
CAMERA    ▷
CLEAR     ▷
FACTORY SET
PTZ RESET

EXIT
< NEAR / RIGHT ▷ MOTION >
    
```

```

MOTION MENU
-----
PRESET ▶
TOUR     ▷
GROUP    ▷
SCAN     ▷
PATTERN  ▷
AREA     ▷
ALARM    ▷
PRIVACY  ▷
HOME POS ▷
BACK     EXIT
< NEAR / RIGHT ▷ PRESET >
    
```

The preset function is that the camera memorizes positions of the pan/tilt and zoom. This function is a representative function of the speed dome which can find memorized preset positions just by selecting the preset No. A Maximum of 255 Preset positions are toured in order.

(1) Select the Preset number

PO01 : Defined Preset number / 001 : Undefined Preset number

Move :  JOYSTICK Select :  NEAR

```

PRESET MENU
-----
NUMBER : 001
TITLE   :
FOCUS   : AUTO
POSITION SET ▶
EXIT TIME : OFF

SAVE    CLR    BACK    EXIT
< NEAR / RIGHT ▷ PRESETNUM >
    
```

```

PRESET MENU
PRESET SELECT : 001
001  002  003  004  005  006
007  008  009  010  011  012
013  014  015  016  017  018
019  020  021  022  023  024
025  026  027  028  029  030
031  032  033  034  035  036
037  038  039  040  041  042
043  044  045  046  047  048
049  050  051  052  053  054

<EXIT ▷ FOCUS NEAR>
    
```

(2) Set the Preset TITLE

Move :  Select :  or  Delete :  or 

It's available to set the desired TITLE, displayed on the executing screen of Preset.



After the TITLE is set, push the NEAR button to exit.

(3) Select the focus mode for Preset

① Select the Focus menu

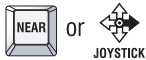

② Move and set the Focus Menu

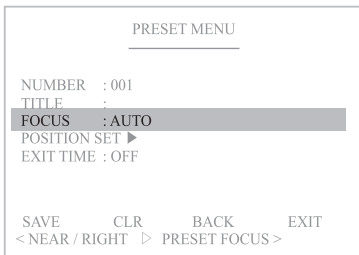

On focus menu, there are 3 modes : AUTO, MANUAL, ONESHT. It allows detailed settings for the preset.

(4) Define the Preset position

① Select the Position menu



② Move and set the position



③ Set & Back

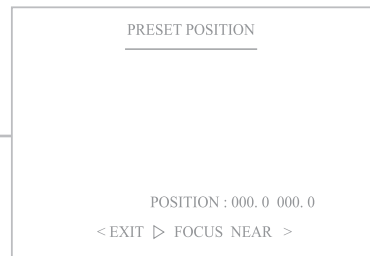
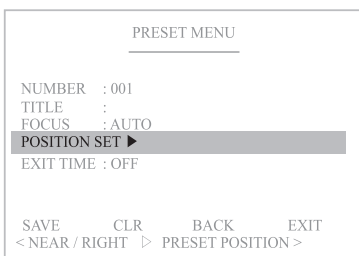

(5) EXIT TIME

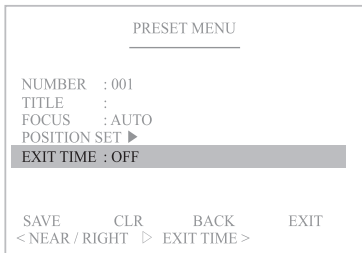

Setting the dwell time to exit Preset mode after completing Preset working.
 (OFF / 5SEC / 10SEC / 20SEC / 30SEC / 1MIN / 5MIN / 10MIN / 30MIN) ※ Default : OFF

Select :  or  Set ON :  Set OFF : 

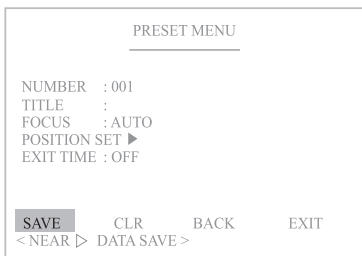

- (6) “Save” above setting Pattern data to the memory.
- (7) “CLR” means above setting Pattern data will not be saved and be cleared.
- (8) “BACK” means it goes back to the previous menu :Motion.
- (9) “EXIT” means it goes out of MENU.

5. 2. 2 Tour

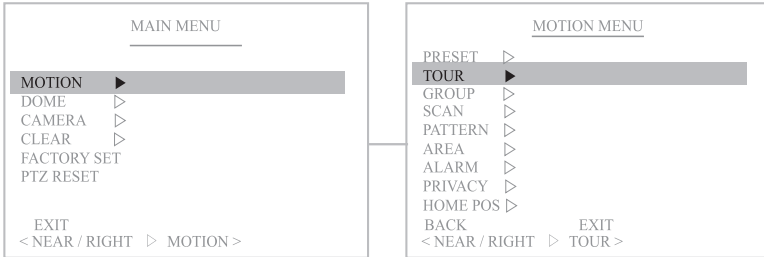

The Tour function consists of several presets run by turn. It is also adjusts the moving speed (1~63 step) and dwell time (1~99secs). Maximum of 8 Tour functions are toured in order. (※ 1 Tour can be set for 16 presets.)

(1) Select the Tour number

T01 : Defined Tour number / 01 : Undefined Tour number

Move :  Select : 

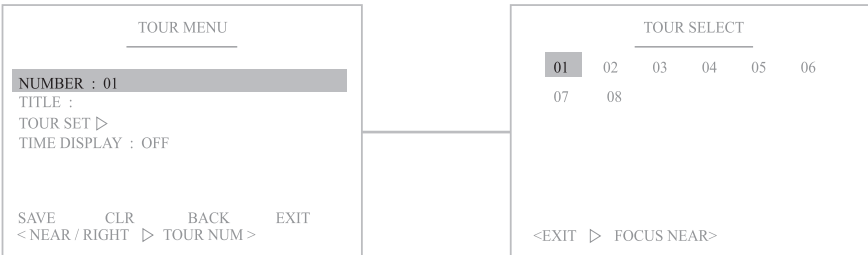

(2) Set the Tour TITLE

Move :  Select :  or  Delete :  or 

It's available to set the desired TITLE, displayed on the executing screen of Tour.



After the TITLE is set, push the NEAR button to exit.

(3) Define the Preset position

- ① Move to the set-up window ② Move and set the position ③ Set & Back

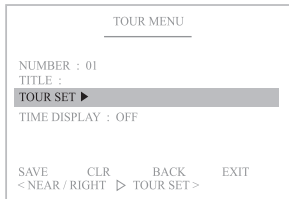
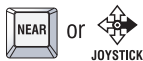

TOUR EDIT (01)			
NO	PRESET	SPEED	DWELL
01	<XXX>	XX	XX
02	XXX	XX	XX
03	XX	XX	XX
04	XX	XX	XX
05	XX	XX	XX
06	XX	XX	XX
07	XX	XX	XX
08	XX	XX	XX
<SEL & NEAR		PRESET & LEFT >	
<SEL & NEAR		DELETE & WIDE >	

TOUR MENU											
PRESET SELECT : 001											
001	002	003	004	005	006	007	008	009	010	011	012
013	014	015	016	017	018	019	020	021	022	023	024
025	026	027	028	029	030	031	032	033	034	035	036
037	038	039	040	041	042	043	044	045	046	047	048
049	050	051	052	053	054	<EXIT > FOCUS NEAR >					

(4) Time Display

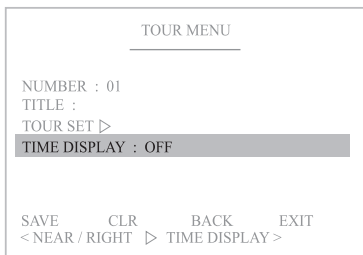

Display the remain time of each Preset dwell time during Tour operation.(OFF / ON) ※ Default : OFF

Select : or Set ON :

Set OFF :

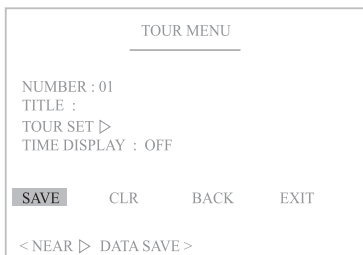

- (4) "Save" above setting Pattern data to the memory.
- (5) "CLR" means above setting Pattern data will not be saved and be cleared.
- (6) "BACK" means it goes back to the previous menu :Motion.
- (7) "EXIT" means it goes out of MENU.

5.2.3 Group

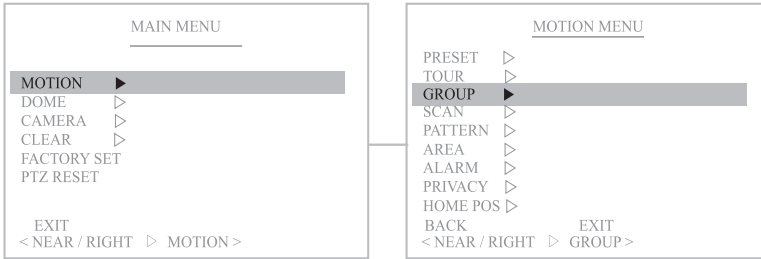

GROUP : You can make Max. 6 groups and call the saved tour by turn.

(1) Select the Group number

G01 : Defined Group number / 01 : Undefined Group number

Set from 1 to 6 groups.

Move :  Select : 

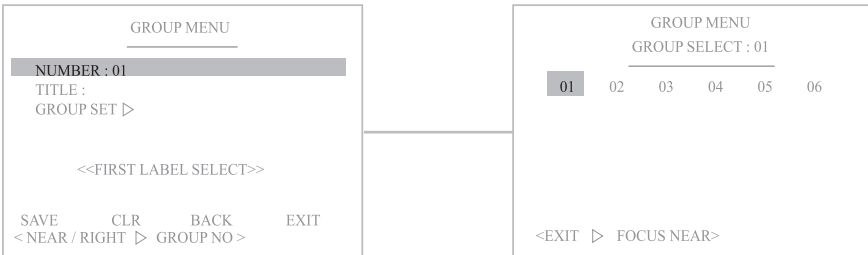

(2) Set the Group Title

Move :  Select :  or  Delete :  or 

It's available to set the desired Title, displayed on the executing screen of Group.

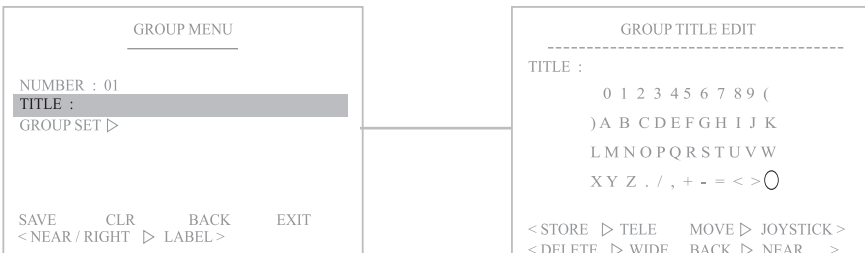

After the Title is set, push the NEAR button to exit.

(3) GROUP SET

① Move to the set-up window

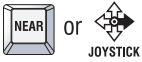

② Move and Delete



③ Set & Back

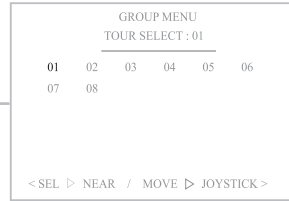
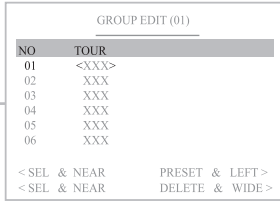
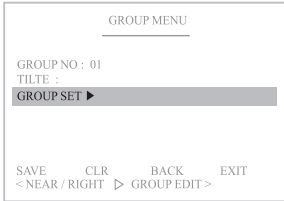

- GROUP EDIT : Set the tour from 1 to 6 of group.

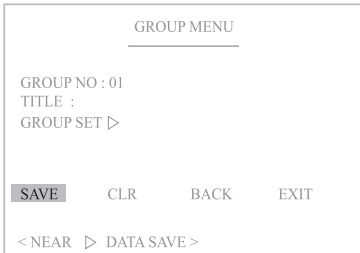

(4) "Save" above setting Pattern data to the memory.

(5) "CLR" means above setting Pattern data will not be saved and be cleared.

(6) "BACK" means it goes back to the previous menu :Motion.

(7) "EXIT" means it goes out of MENU.

5.2.4 Scan

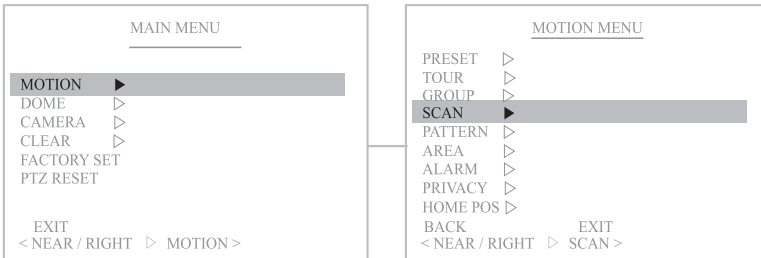

The Scan function means that the camera keeps panning between two programmed pan positions. It is also adjusts the moving speed(1~63 step). Maximum 8 Scan functions are toured in order.

(1) Select the Scan number

S01 : Defined Scan number / 01 : Undefined Scan number

Move :  Select : 

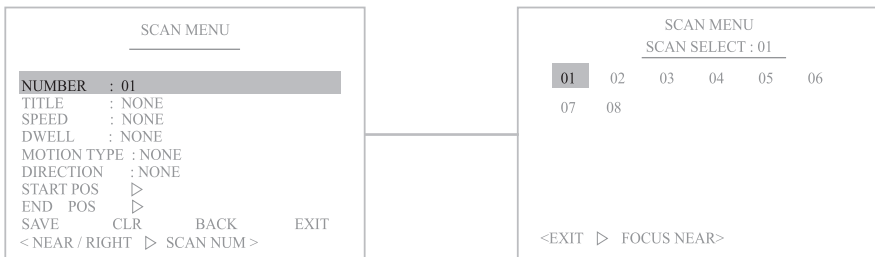

(2) Set the Scan TITLE

Move :  Select :  or  Delete :  or 

It's available to set the desired TITLE, displayed on the executing screen of Scan.

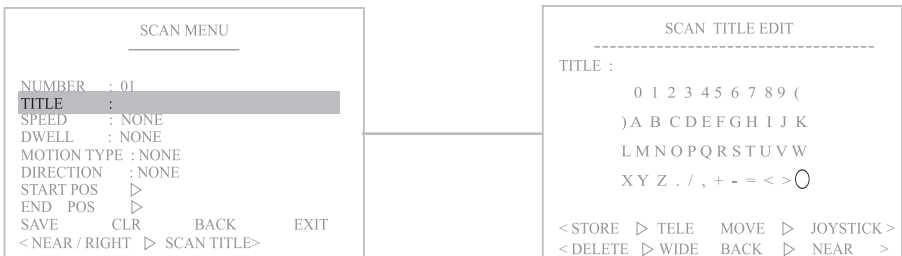

After the TITLE is set, push NEAR button to go out.

(3) Set the Scan speed

Increase :  or 

Decrease :  or 

It adjusts the moving speed from 1~63 steps.

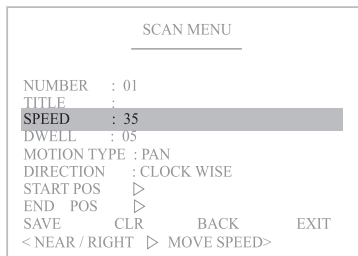

(4) Set the Dwell Time

Increase :  or 

Decrease :  or 

Dwell time means the time that the camera stay at the start & end pan positions.
It's adjustable from 00~59 seconds.

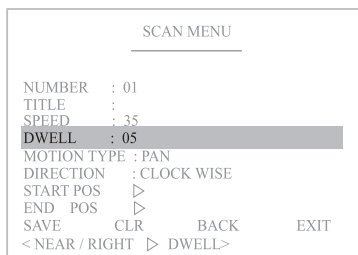

(5) Set the Motion Type

Set PAN/TILT direction

When PAN is set, PAN SCAN is proceeded with the specified coordinate value.

When TILT is set, TILT SCAN is proceeded with the specified coordinate value.

Select :  or  Set ON : 

Set OFF : 

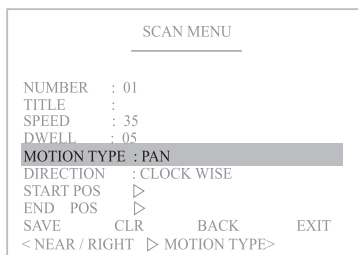



(6) Set the Direction

PAN : Select Clock Wise or C_Clock Wise direction

When select C_Clock WISE, counterclockwise progression

When select Clock WISE, clockwise progression

TILT : Set the UP & DOWN.

Select :  or  Set ON : 

Set OFF : 

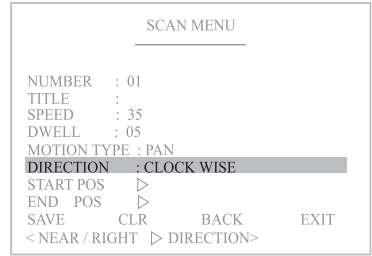

(7) Define the Start position

① Select Start Pos menu

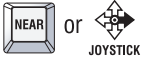

② Move and set the position



③ Go back

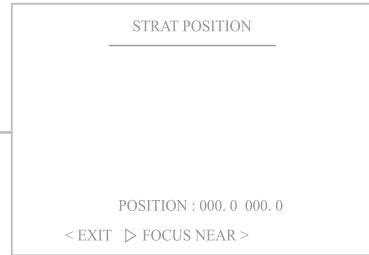
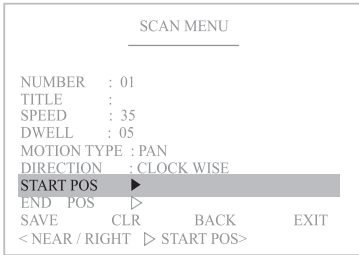

(8) Define the End position

① Select End Pos menu



② Move and set the position



③ Go back

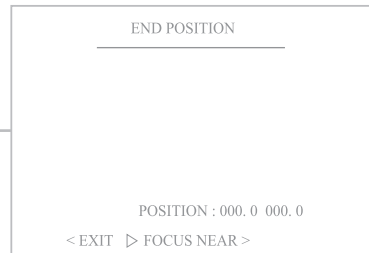
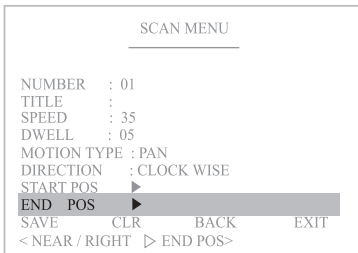

- When Motion type is PAN, Pan is available.
- When Motion type is TILT, TILT is available.

(9) "Save" above setting Pattern data to the memory.

(10) "CLR" means above setting Pattern data will not be saved and be cleared.

(11) "BACK" means it goes back to the previous menu :Motion.

(12) "EXIT" means it goes out of MENU.

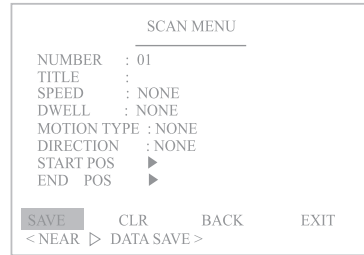

5.2.5 Pattern

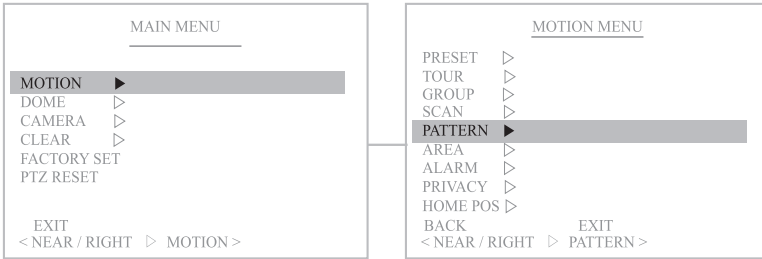

The Pattern function memorizes User's random moving path and zoom ratio. Total recording time limit is 65secs and maximum 4 Pattern functions are toured in order.

(1) Select the Pattern number

PAT01 : Defined Pattern number / 01 : Undefined Pattern number

Move :  Select : 

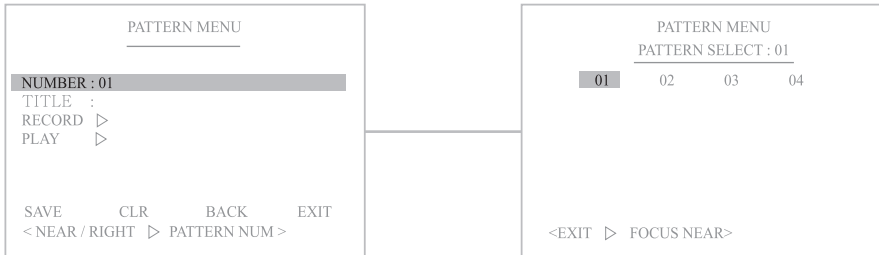

(2) Set the Pattern TITLE

Move :  Select :  or  Delete :  or 

It's available to set the desired TITLE, displayed on the executing screen of Pattern.



After the TITLE set, push NEAR button to go out.

(3) Record and Save the User's random Pattern data

① Select the "Record" Menu

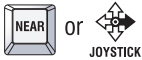

② Move and record the pattern



③ NEAR -> EXIT

FAR -> RECORD ON

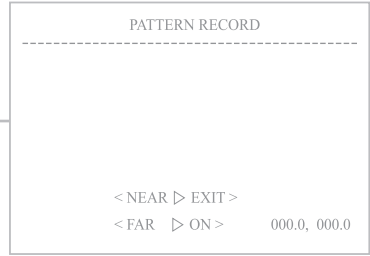
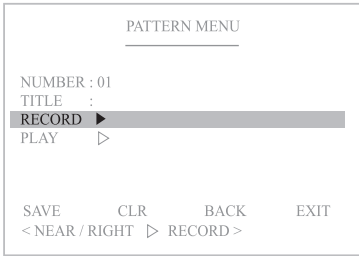

(4) Play back the recorded Pattern data

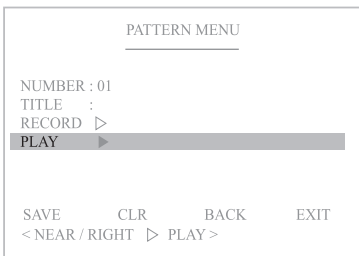

(5) "Save" above setting Pattern data to the memory.

(6) "CLR" means above setting Pattern data will not be saved and be cleared.

(7) "BACK" means it goes back to the previous menu :Motion.

(8) "EXIT" means it goes out of MENU.

5. 2. 6 Area

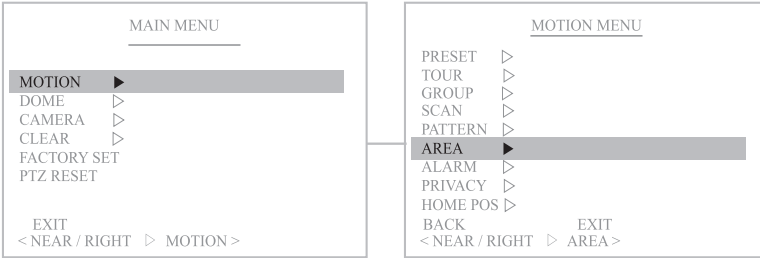

The Area function means that it displays the Area name between two programmed pan positions. Maximun 16 Area functions are toured in order.

(1) Select the Area number

AR 01 : Defined Area number / 01 : Undefined Area number

Move :  Select : 



(2) Set the Area TITLE

Move :  Select :  or  Delete :  or 

It's available to set the desired TITLE, displayed on the executing screen of Area.



After the TITLE set, push NEAR button to go out.

(3) Set the Direction

Select :  or  Set ON :  Set OFF : 

C_Clock WISE is counterclockwise mark, Clock WISE is clockwise mark.

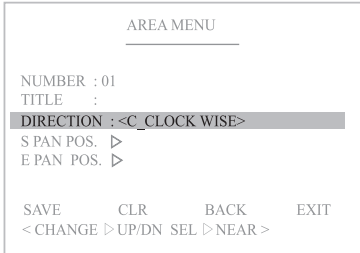

(4) Define the Start pan position

- ① Select the "Start Pan Pos" menu
- ② Move and set the position
- ③ Set & Back

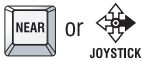

- ② Move and set the position



- ③ Set & Back

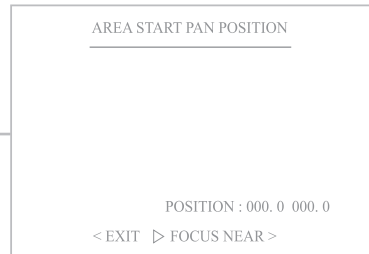
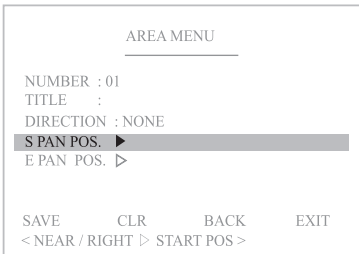

(5) Define the END pan position

- ① Select the "END Pan Pos" Menu
- ② Move and set the position
- ③ Set & Back

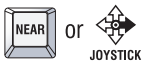

- ② Move and set the position



- ③ Set & Back

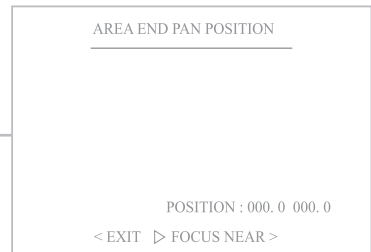
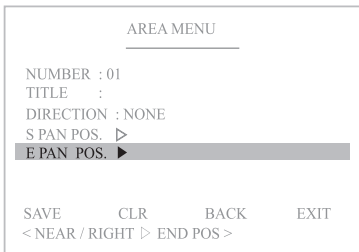

- (6) "Save" above setting Area data to the memory.
- (7) "CLR" means above setting Area data will not be saved and be cleared.
- (8) "BACK" means it goes back to the previous menu :Motion.
- (9) "EXIT" means it goes out of MENU

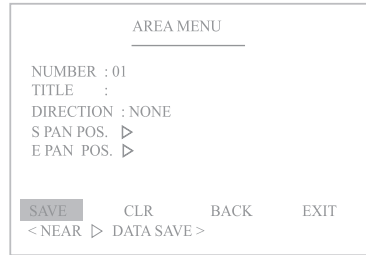

5.2.7 Alarm

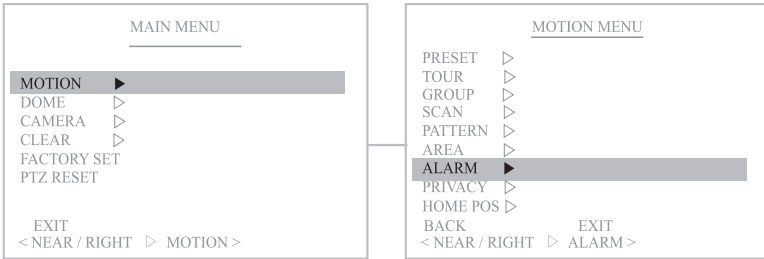

The Alarm function means that the camera moves to the programmed Preset position by the Alarm trigger. 2 Alarm functions are toured in order.

(1) Select the Alarm number

A01 : Defined Alarm number / 01 : Undefined Alarm number

Move :  JOYSTICK Select : 



(2) Set the Alarm TITLE

Move :  JOYSTICK Select :  or  JOYSTICK Delete :  or  JOYSTICK

It's available to set the desired TITLE, displayed on the executing screen of Alarm.



After the TITLE is set, push the NEAR button to exit.

(3) Define the Preset position with Alarm trigger

① Select the "Preset Num"

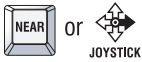

② Move and set the position



③ Set & Back

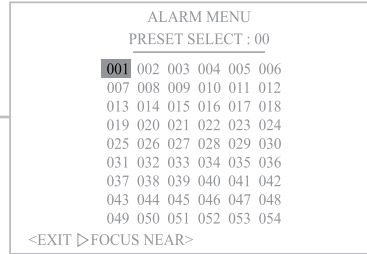
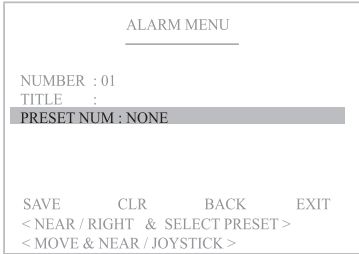

(4) "Save" above setting Alarm data to the memory.

(5) "CLR" means above setting Alarm data will not be saved and be cleared.

(6) "BACK" means it goes back to the previous menu :Motion.

(7) "EXIT" means it goes out of MENU

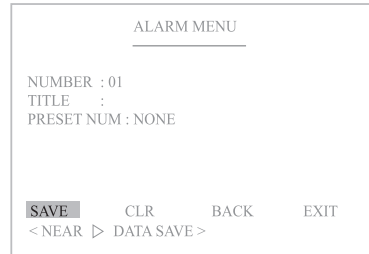

5. 2. 8 Privacy Zone Masking

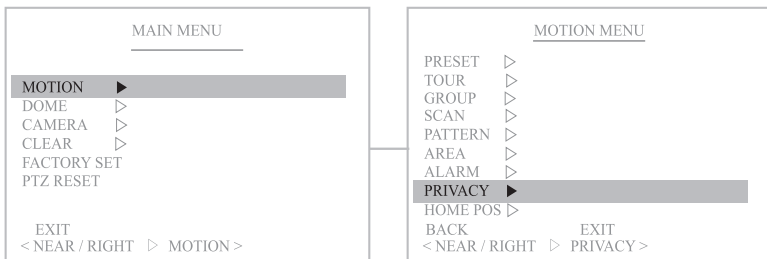

The Privacy Zone Masking function means that it sets the blocking territories to prevent camera functions for the privacy of personal reasons. Maximum of 8 Privacy Zone Masking functions are toured in order.

(1) Select the Privacy Zone number

PR01 : Defined Alarm number / 01 : Undefined Alarm number

Move :  Select : 

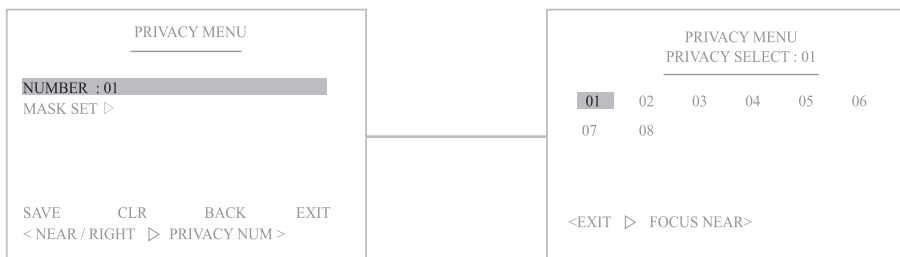

(2) Mask set

Move :  Select :  or  Delete :  or 

It's available to set the desired position and size of the blocking territories freely.

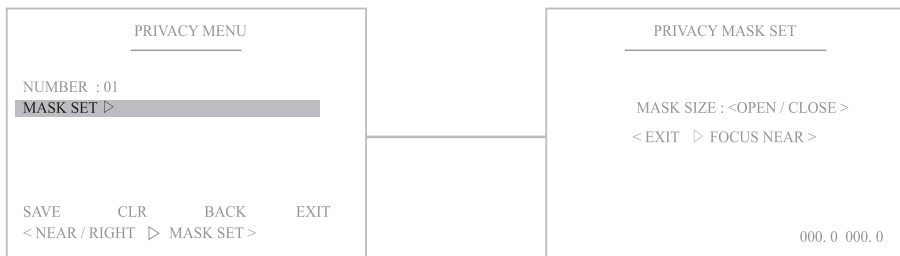

After the Privacy Zone is set, push the NEAR button to go out.

- (3) "Save" above settings of Privacy Zone data to the memory.
- (4) "CLR" means above setting of Privacy Zone data will not be saved and be cleared.
- (5) "BACK" means it goes back to the previous menu :Motion.
- (6) "EXIT" means it goes out of MENU.

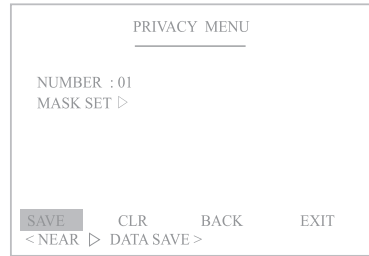

5.2.9 Home Position

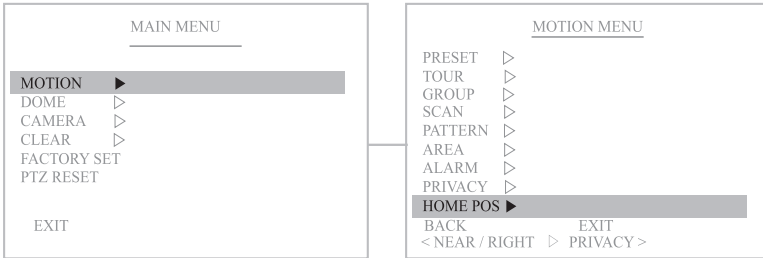

Home Position specify the main image display area.

(1) Home Position ON/OFF setting

Move :  Select : 

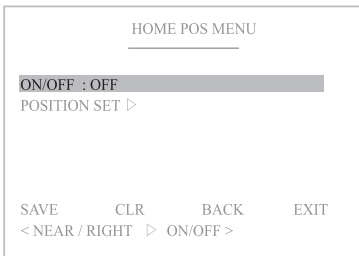

(2) Home Position SET

Move :  Select : 



5.3 Dome Setting



Pan, Tilt, Zoom motion is adjustable in the “Dome Setting” Menu.

5.3.1 Set the Dome camera title

Move :  JOYSTICK Select :  or  JOYSTICK Delete :  or  JOYSTICK

It's available to set the desired camera title.

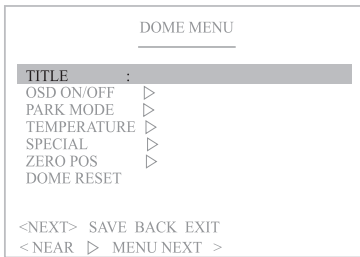

After the TITLE is set, push NEAR button to exit.

5.3.2 OSD ON/OFF Set

You can select the OSD ON to shown on the screen or clear by selecting OFF in this function.

Select :  JOYSTICK or  NEAR Set ON :  JOYSTICK Set OFF :  NEAR

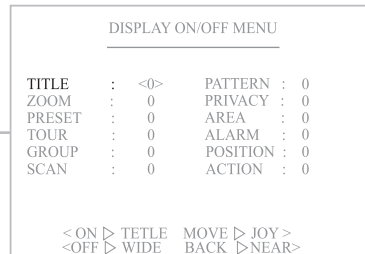
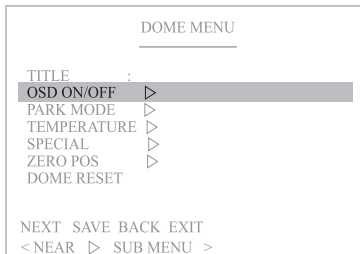

5.3.3 PARK MODE

This function enables to locate the camera to specific position automatically if operator doesn't operate the controller for a while.



- ON/OFF : Select ON/OFF
- TIME : Select 10 sec~1 HOUR
- MOTION : Set PRESET / PATTERN / SCAN GROUP / TOUR
- NUMBER
PRESET : 1~255
PATTERN : 1~4
SCAN : 1~8
GROUP : 1~6
TOUR : 1~8

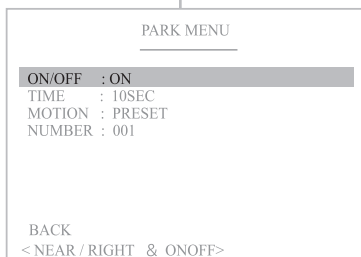
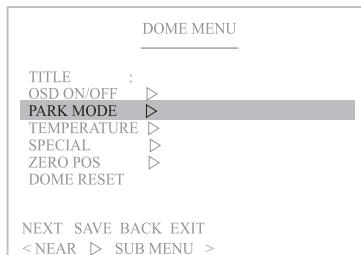

5.3.4 TEMP MODE

It shows you the current temperature and you can also set the value manually. The compulsory Fan & Heater operation is a useful function to remove humidity.

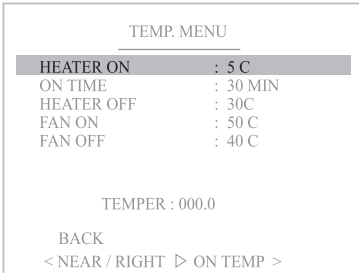
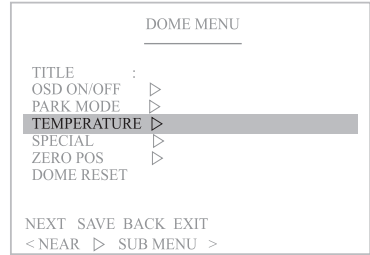

(1) HEATER ON

Set the operating temperature of the heater. (0~70°C)

Select :  or  Set ON : 

Set OFF : 

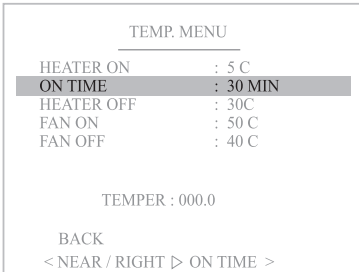

(2) ON TIME

Set the operating time of the heater.
 - By 10min. (10~60 min.)

Select :  or  Set ON : 

Set OFF : 

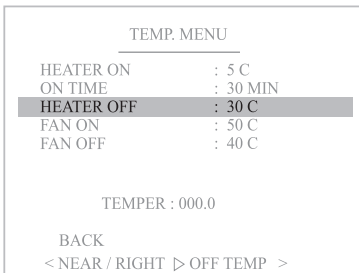

(3) HEATER OFF

Set the temperature of heater OFF. (0~70°C)

Select :  or  Set ON : 

Set OFF : 

TEMP. MENU	
HEATER ON	: 5 C
ON TIME	: 30 MIN
HEATER OFF	: 30 C
FAN ON	: 50 C
FAN OFF	: 40 C
TEMPER : 000.0	
BACK	
< NEAR / RIGHT ▷ FAN ON >	

(4) FAN ON

Set the operating temperature of the Fan. (0~70°C)

Select :  or  Set ON : 

Set OFF : 

TEMP. MENU	
HEATER ON	: 5 C
ON TIME	: 30 MIN
HEATER OFF	: 30 C
FAN ON	: 50 C
FAN OFF	: 40 C
TEMPER : 000.0	
BACK	
< NEAR / RIGHT ▷ FAN OFF >	

(5) FAN OFF

Set the temperature of Fan OFF. (0~70°C)

Select :  or  Set ON : 

Set OFF : 

5.3.5 Special

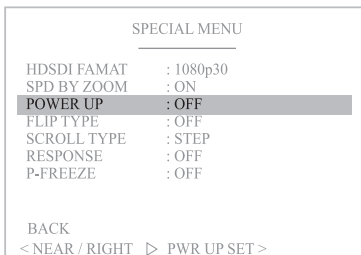
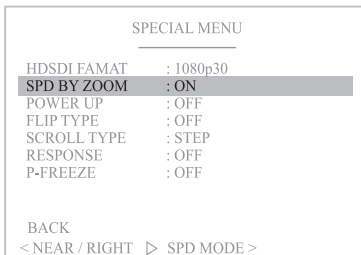
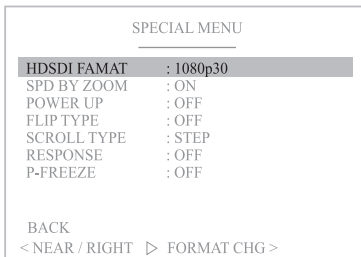
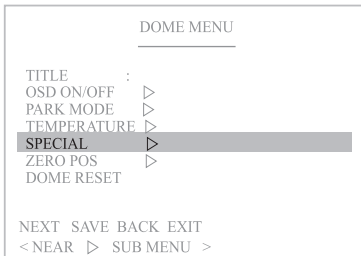

(1) HDSDI FORMAT

- 1080p/30(25)fps / 1080p/60(50)fps /
720p/30(25)fps / 720p/60(50)fps

* Video format setting depends upon the models.

* Video format is not applied for analogue models.

Select :  or  Set ON : 

Set OFF : 

(2) Speed by Zoom

Adjust PAN/Tilt Speed by Zoom ration.
(Available to check with max zoom rate.)

Select :  or  Set ON : 

Set OFF : 

(3) POWER UP

When this function is ON, the camera memorizes the latest action and restores, it from sudden power failure.

Select :  or  Set ON : 

Set OFF : 

SPECIAL MENU	
HSDSI FAMAT	: 1080p30
SPD BY ZOOM	: ON
POWER UP	: OFF
FLIP TYPE	: OFF
SCROLL TYPE	: STEP
RESPONSE	: OFF
P-FREEZE	: OFF
BACK	
<NEAR / RIGHT ▷ TYPE>	

(4) FLIP TYPE

- ON : When TILT move to 90°, PAN 180° automatically reversed moved
- OFF : TILT movement ranges from 0 ~90°

Select :  or  Set ON : 

Set OFF : 

SPECIAL MENU	
HSDSI FAMAT	: 1080p30
SPD BY ZOOM	: ON
POWER UP	: OFF
FLIP TYPE	: OFF
SCROLL TYPE	: STEP
RESPONSE	: OFF
P-FREEZE	: OFF
BACK	
<NEAR / RIGHT ▷ TYPE>	

(5) SCROLL TYPE

Set the cursor progress
STEP : by 1 STEP
AUTO : Continuous scroll



Select :  or  Set ON : 

Set OFF : 

SPECIAL MENU	
HSDSI FAMAT	: 1080p30
SPD BY ZOOM	: ON
POWER UP	: OFF
FLIP TYPE	: OFF
SCROLL TYPE	: STEP
RESPONSE	: OFF
P-FREEZE	: OFF
BACK	
<NEAR / RIGHT ▷ ON/OFF>	

(6) RESPONSE TXD

Tx communication line to transfer the unique value of protocol response.
(Use this function when the protocol is pelco-D 5.0 EZ.)

Select :  or  Set ON : 

Set OFF : 

SPECIAL MENU	
HSDSI FAMAT	: 1080p30
SPD BY ZOOM	: ON
POWER UP	: OFF
FLIP TYPE	: OFF
SCROLL TYPE	: STEP
RESPONSE	: OFF
P-FREEZE	: OFF
BACK	
<NEAR / RIGHT ▷ ON/OFF>	

(7) P-FREEZE

The screen is stopped while the camera is operating presetfunction.

Select :  or  Set ON : 

Set OFF : 

5. 3. 6 ZERO POS

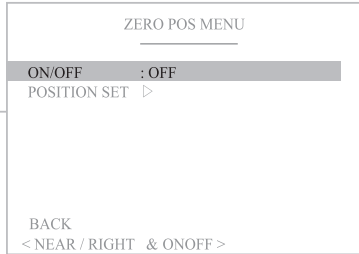
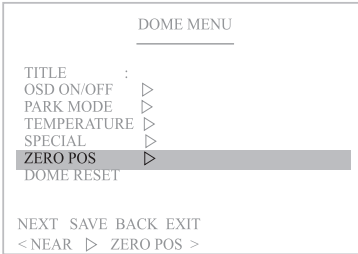

When select ON, the zero position is changeable.
 POSITION change 000.0 / 000.0 value.

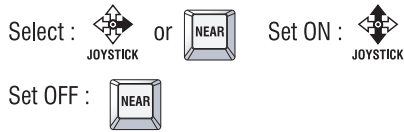

5. 3. 7 DOME RESET

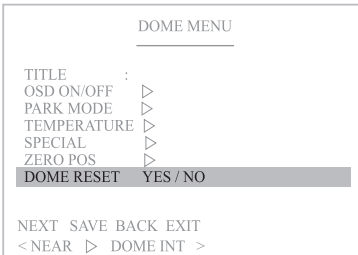

DOME MENU initialization function.

4. 3. 8 EXT LED MODE

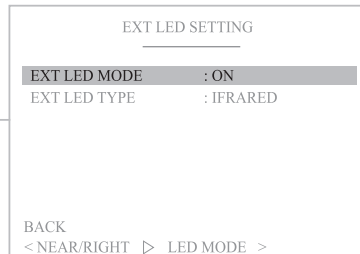

1. EXT LED MODE : EXTEND IR LED MODE(ON/OFF)
2. EXT LED TYPE : EXTEND IR LED TYPE(INFRARED, WHITE)

5.4 Clear Setting

Clears the PTZ position and function value.

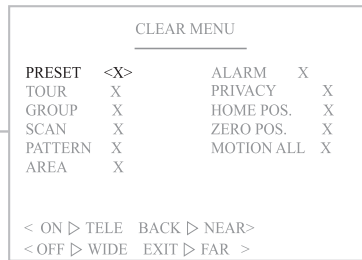
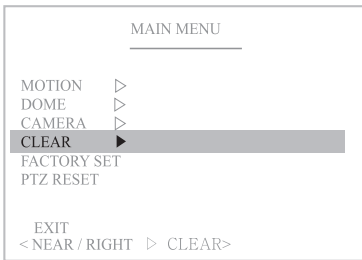

select :  or  Set ON : 

Set OFF : 

5.5 Factory set

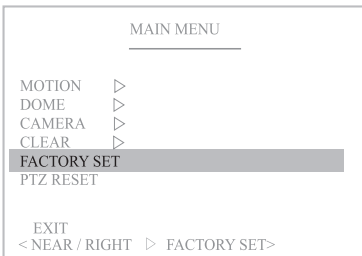

 Restore setting values to the factory default.
 All existing setting value will be erased.

5.6 PTZ Reset

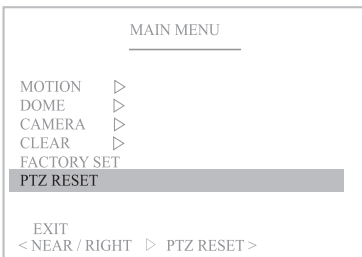

It is a reset function.

6. SPECIFICATIONS

6.1 Mechanical Specifications

6.1.1 MECHANICAL

Pan	: 360° Continuous Pan, 0.1° to 100°/sec.
Pan Preset Speed	: 110°/sec, 0.3° Accuracy
Tilt	: TOP 345°~90° , BOTTOM 15°~270° tilt angle , Proportional to zoom
Tilt Preset Speed	: 60°/sec, 0.3° Accuracy
Weight	: Standard Model : Approx. 2.7kg / Packing 3.2kg : Additional LED Model : Approx. 3.5kg / Packing 4kg

6.1.2 ENVIRONMENTAL

Construction	: Die-casing Aluminum : All internal parts are corrosion protected epoxy powder coating
Ingress Protection	: IP66 Outdoor Application
Color	: Ivory and Black
Operating Temp	: -20°C to 50°C (In continuous operation with Fan & Heater)
Storage Temp	: -20°C to 50°C
Humidity	: 0% to 90%

6.1.3 FUNCTIONS

Preset	: 255 points
Tour	: 8 programmable
Pattern	: 4 patterns for Max. 65 second.
Scan	: 8 programmable speed and diagonal scan
Area	: 16 Area Title
Alarm	: 2 alarm
Flip	: Mechanical Auto Flip On/Off
Address	: Up to 255 selectable ID(setting with Dip-switches)
Data Communication Control	: RS-485/ RS-422
Protocol	: Multiple Protocol (WTX, PELCO-D V1, PELCO-P, PELCO-D V5)
Baud rate	: 2400, 4800, 9600, 19200, 38400, 57600, 115200 bps selectable

6.1.4 ELECTRICAL

Power	: DC 12V~DC 24V
Power Consumption	: MIN 1.5A, 18W / MAX 3.5A, 40W(FAN&HEATER&IR&IP ON)

* The default operating temperature of fan/heater may need to be changed depending on the installation environment.

6.2 LED Specifications

	Infra Red LED
Light Distance	120m manual focusing
LED	12pcs of 18ø IR Lens

· 12VDC model is designed for vehicle application. Ground for both power and video is just one and therefore the power is not isolated and may be damaged by surge input if it is installed in general circumstances not in a vehicle.

7. DIMENSIONS(mm)

7.1 Standard Model

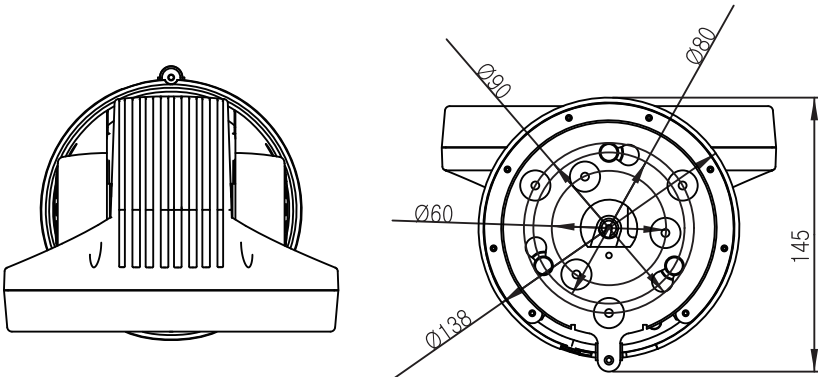
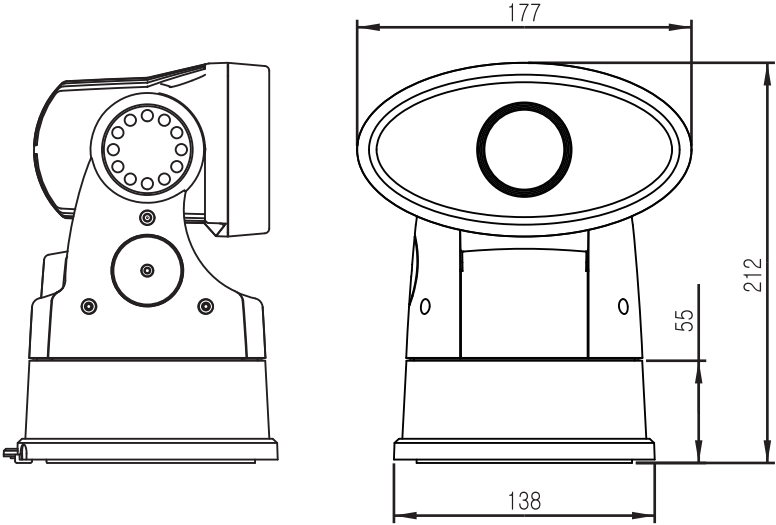

7.2 Optional Bracket (Vihechle bracket)

VB1

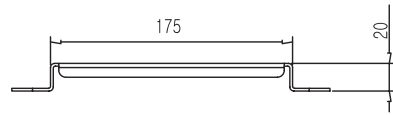
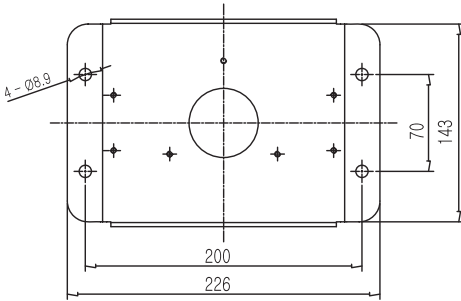
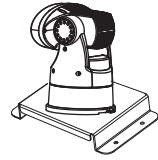

VB2

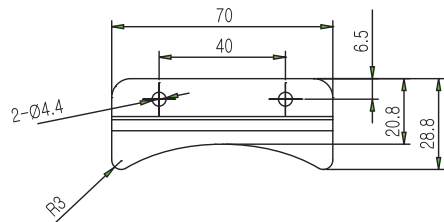
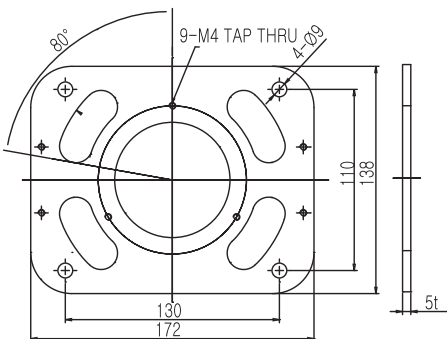

8. FROUBLE SHOOTING

If you have trouble with operating camera, refer to the following table.

If the guidelines do not enable you to solve the problem, contact an authorized technician.

Problem	Solution
No video.	Check that the power is connected to all pieces of equipment in the system. Check that the BNC connectors are inserted properly. Check if the iris of the lens is closed and adjust that. Check the camera's fixed shutter menu and adjust that.
Poor Video Quality.	Check the voltage level of the camera. Check the power supply voltage.
Controller does not work.	Check if the camera and peripheral devices are properly connected. Verify the setups of ID, protocol, and baud rates.
Too dark or bright video.	Check the camera's Brightness Level and adjust that.
Focus out video.	Check the dome cover or camera lens and clean the dirt off. If Auto Focusing is having difficulty focusing on a particular subject, set Focus mode to Manual and adjust the focus by yourself. Reset the camera referring to camera manual.
LED does not work.	Check if light mode is set correctly referring to camera manual. Check the Day & Night mode and converting Lux value referring to camera manual.
Day or night mode does not convert automatically.	Check that Day & Night mode is set to AUTO mode referring to camera manual. Check the converting Lux value and adjust according to surrounding's illumination referring to camera manual. Check if the CDS sensor(there's blue one beside of LED) is covered by something.
Pan, Tilt, Zoom do not work.	Check that the power is connected to all pieces of equipment in the system. Check that the BNC connectors are inserted properly.